

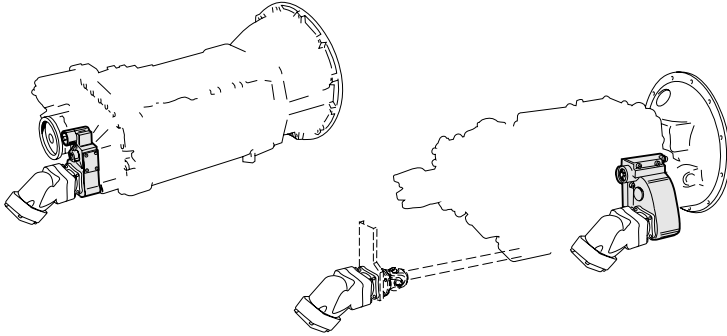

Gearbox-mounted power take off (under clutch control)

Hydraulic power is used when the vehicle is stationary. A power take off with a high ratio (greater than 1:1) gives a large flow with a small pump. Choose a low ratio (less than 1:1) to avoid overspeeding when controlling from the driver's position.



Pump choice: SAP, SCP or SLPD

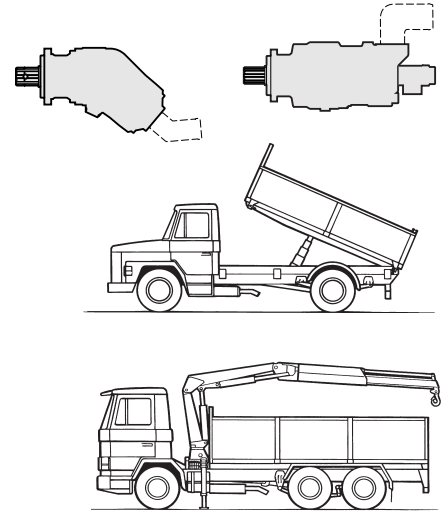

Engine-mounted power take off (not under clutch control)

Hydraulic power is mainly used when the vehicle is moving.

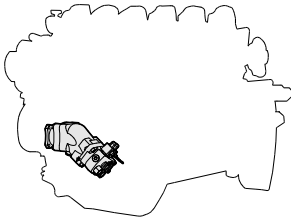

Pump choice: SAP, SCP, SCPD
with By-Pass or
SLPD with Savtec®

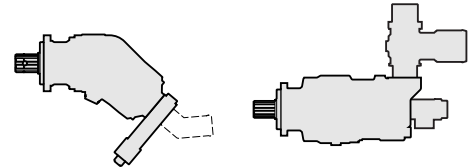

Combined vehicle

Road-maintenance vehicles, etc. Hydraulic power is also used when the vehicle is in motion. Choose a power take off with a low ratio to avoid overspeeding.

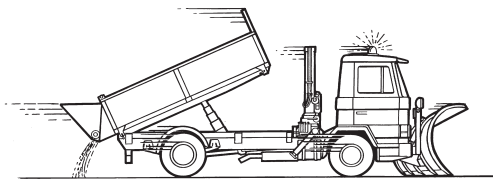

Pump choice: SAP, SCP, SCPD
with By-Pass or
SLPD with Savtec®

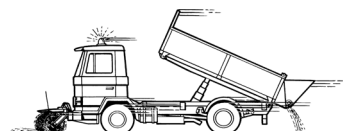
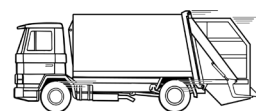
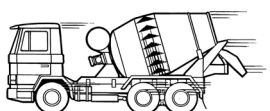
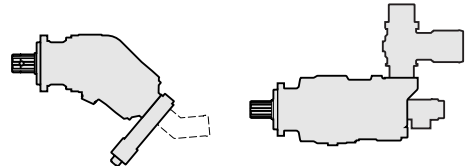

Choice of pump size

Displacement D

$$D = \frac{Q_1 \cdot 1000}{n_M \cdot z} \quad (\text{cm}^3/\text{rev})$$

Q_1 = Flow demand (l/min)
 n_M = Engine speed (rpm)
 z = PTO ratio

Torque M

$$M = \frac{D \cdot p}{6.3} \quad (\text{Nm})$$

D = Pump displacement (cm^3/rev)
 p = Working pressure (MPa)

$$Q_2 = \text{Flow (l/min)} = \frac{D \cdot n_M \cdot z}{1000}$$

Power P

$$P = \frac{Q_2 \cdot p}{60} \quad (\text{kW})$$

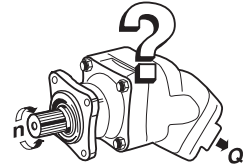

Calculation of "pump size", i.e. displacement

Example 1: A crane has a flow demand of 60 l/min. The engine speed selected is 900 rpm and the ratio of the power take off is 1:1.4. What pump is appropriate?

$$D = \frac{60 \cdot 1000}{900 \cdot 1.4} = 47.6 \text{ cm}^3/\text{rev}.$$

Select pump SAP/SCP 047

N.B. Check that the speed of the pump ($n_{\text{pump}} = z \cdot n_M$) does not exceed the max recommended speed.

Calculation of torque and power output

Example 2: What will the torsional load and the power output be with the power take off in Example 1 when the working pressure is 28 MPa (280 bars)?

$$M = \frac{47.6 \cdot 28}{6.3} = 209 \text{ Nm} \quad P = \frac{59.3 \cdot 28}{60} = 27.7 \text{ kW}$$

N.B. In order to avoid overloading, compare the torsional load 209 Nm and the power output 27.7 kW with the maximum permissible values for the power take off.

System construction

Oil tank

Oil volume (l)

- At least equal to the oil flow (l/min.) with short working cycles e.g. tipper operations
- At least 1.5 times the oil flow with long working cycles e.g. a forestry crane
- At least twice the oil flow in continuous operation

The following will be required to prevent foaming:

- Return filter with canister
- Air filter
- Large ventilated area
- Long distance between suction and return connections

The upper side of the tank must be sealed so that water cannot run in. The tank should preferably be placed so that the oil level is higher than the pump.

- Choose a large-bore suction line of the shortest possible length to avoid cavitation
- Use of a suction strainer is advisable to catch coarse particles from the oil tank (SLPD only)
- Choose large-bore pressure and return lines so as to avoid pressure losses (heat generation)

NOTE! A pressure limiting valve with capacity for the intended flow must always be fitted to the system. On removable equipment with quick connectors the pressure limiting valve must be installed before the quick connector.

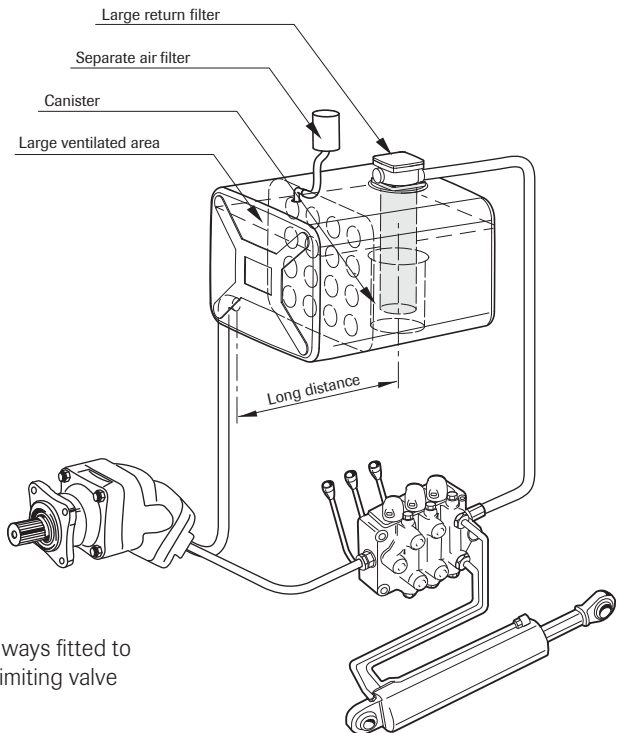

Recommended line size (d_i)

The recommendations do not apply to SCPD 76/76 and SVH. See the relevant installation instructions for these pumps.

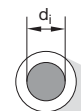
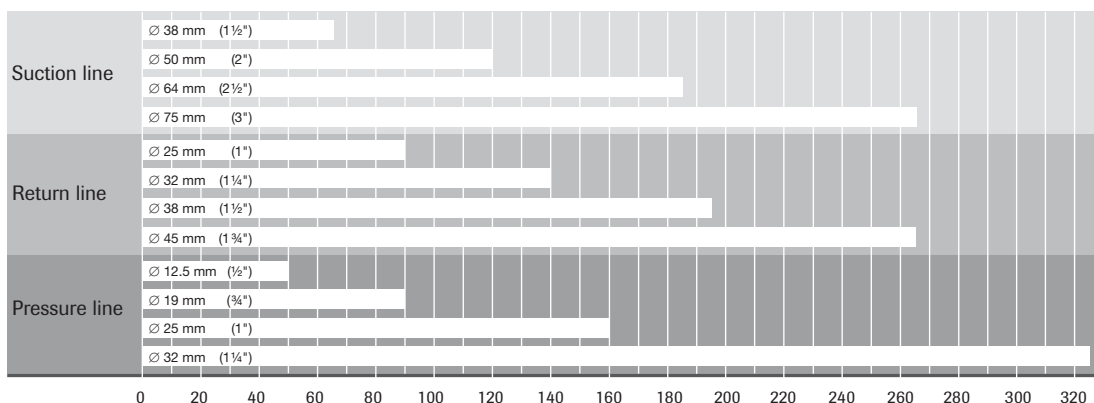

If the suction pipe is more than 2 m long the internal diameter must be increased by 10 mm for each meter extension.

Flow litres/min

Filtering

Investing in cleanliness is worthwhile:

- Halving of the amount of particles doubles component life
- Halving of the amount of particles reduces the degree of malfunction by half

To conform to most market demands on operating reliability and life span the impurity level of the oil should correspond to class 18/16/13 as set out in ISO 4406.

Consequently, the hydraulic system is equipped with a return filter and air filter with a degree of filtration equal to 10 µm absolute.

Furthermore, the hydraulic system should be equipped with a pressure filter if necessary.



Changing the filter: First change after 50 hours of operation. Then whenever the filter pressure indicates too high a pressure at the normal operating temperature for hydraulic oil. A good rule is to change the air filter at the same time.

Contamination level 18/16/13

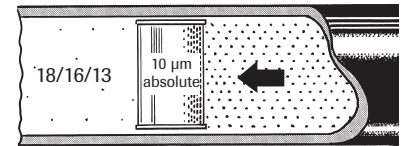

Between 1300 up to (and including) 2500 number of particles equal to or larger than 4 µm(c) per millilitre of fluid.

Between 320 up to (and including) 640 number of particles equal to or larger than 6 µm(c) per millilitre of fluid.

Between 40 up to (and including) 80 number of particles equal to or larger than 14 µm(c) per millilitre of fluid.

Hydraulic oil

Quality:

- Mineral oil
Use a high quality oil whose minimum technical properties conform to the following requirements:
ISO type HM VG 32-68 depending on the ambient air temperature.
Alternatively DIN 51524-2 HLP
- Environment oil
Use synthetic ester that conforms to the technical requirements above.

Viscosity:

The viscosity of the hydraulic oil drops (the oil becomes thinner) when the temperature rises. An ideal choice is an oil with a high viscosity index (VI). A higher VI gives less viscosity variation when the temperature changes.

- At a viscosity higher than 1500 cSt (limit for cold start) the pump cannot suck in oil
- At a viscosity lower than 10 cSt the lubrication capacity is insufficient. System efficiency will also be impaired
- When there is a risk of the oil temperature in the oil tank exceeding 60 °C, an oil cooler must be used
- Pumps/Motors can manage a start temperature as low as -40 °C (because the material in the seals is heated by friction immediately)

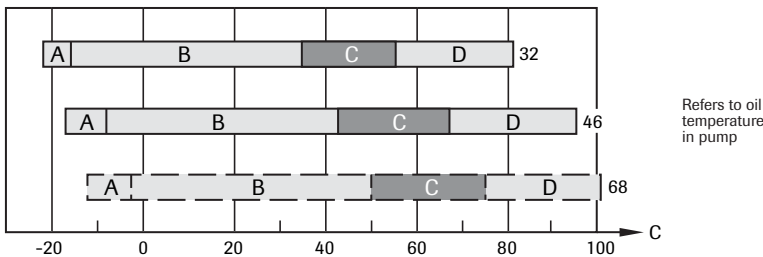

E.g. Hydraulic oil 32: The designation "32" denotes the viscosity is 32 cSt at 40 °C. Lowest start temperature will be -23 °C and highest working temperature 82 °C. Ideal working temperature is 35 - 55 °C.

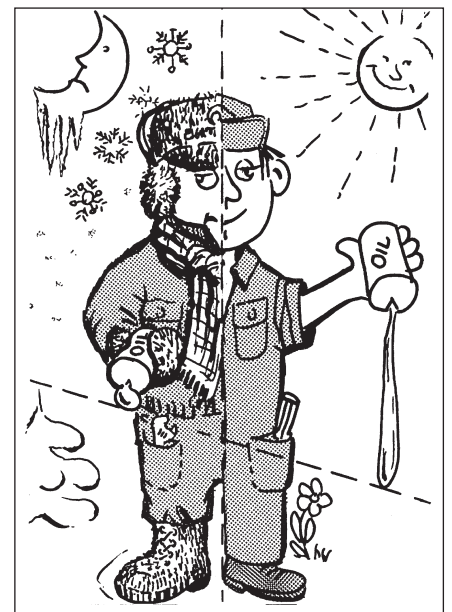

A = The hydraulic system can be started but not loaded. Only circulation pumping at idling speed 1500-700 cSt.

B = The system can be loaded 700-40 cSt.

C = Ideal working range 40-20 cSt.

D = Highest recommended operating temperature 20-10 cSt.

NOTE! The diagram displays hydraulic oil with viscosity index VI ≈ 180.

Water in the hydraulic oil

- Corrosion on component surfaces
- Breakdown of the hydraulic oil
- The lubrication performance deteriorates and wear increases
- Ice formed at freezing temperatures may clog up the system

Oil filling - Oil changing

- New hydraulic oil in a drum has too high an impurity level. Filling should therefore be done with the help of a filter unit or through the oil tank's return filter
- Do not mix oil of a different quality, viscosity or brand. This will impair the technical properties of the oil
- In the event of a pump breakdown: Change the oil or pass it through the filter unit and replace the filter cartridge before putting the pump back into service
- The oil should be changed about every 1000 running hours, though at least once a year. Change the filter cartridge as well

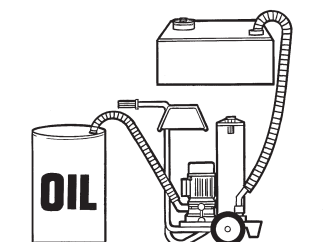

Rectifying a malfunctioning hydraulic system

Fault	Troubleshooting	Cause	Action
The equipment works jerkily	Check whether the flow in the pressure hose from the pump pulsates. Oil spots on the pump and suction hose can indicate an air leakage Check the oil level in the tank Check whether the oil foams	<ol style="list-style-type: none"> 1. Pump not vented after installation 2. Air leakage on the suction hose or pump 3. Oil level too low 4. Not optimal designed tank for separation of air from the oil 5. Oil tank with too small air venting area 6. Dirt in the pressure or suction valve (SLPD) 7. Defective pressure or suction valve (SLPD) 	<ol style="list-style-type: none"> 1. Vent the pump 2. Repair the air leakage 3. Fill with oil 4. Replace the return filter with an oil pipe or tank with solid baffle plate 5. Change to a tank with a greater air venting area 6. Remove the dirt (see dism. of pump) 7. Replace the pump
The equipment works jerkily when starting and at a high pump speed	Check whether the pump cavitates. This is noticeable through flow pulsations and noise from the pump stopping when the speed is lowered	<ol style="list-style-type: none"> 1. Too small diameter on the suction hose 2. Crushing or restriction of the suction hose 3. Blocked suction strainer (SLPD). 4. Oil too thick 5. Underpressure in the oil tank 	<ol style="list-style-type: none"> 1. Change to a suction hose with a larger diameter 2. Remove the restriction 3. Replace the suction strainer. 4. Change to an oil with a lower viscosity 5. Change the air filter
The oil has an abnormally high temperature	Run the pump unloaded at working speed and measure the counter pressure. Connect a pressure gauge to the pressure hose close to the pump. The pressure must not exceed 2 MPa. Check whether the pressure rises to the correct value when a function is run towards the stop	<ol style="list-style-type: none"> 1. Too small a diameter or restriction in the pressure or return hoses 2. Clogged pressure or return filter 3. Oil flow too great 4. Pressure relief valve tripped at too low a pressure 5. Oil too thin 6. Oil tank too small 7. Oil level too low 8. High continuous power output 	<ol style="list-style-type: none"> 1. Change to hoses with a larger diameter; rectify the restriction 2. Replace the filter 3. Lower the speed or change to a smaller pump 4. Adjust the valve or replace if necessary 5. Change to an oil with a higher viscosity 6. Change to a larger oil tank 7. Fill with oil 8. Fit an oil cooler
The equipment has a lack of power	Check whether the pressure rises to the correct value when a function is run towards the stop	<ol style="list-style-type: none"> 1. Pressure relief valve tripped at too low a pressure 2. Defective directional control valve 	<ol style="list-style-type: none"> 1. Adjust the valve or replace if necessary 2. Replace the directional control valve
The equipment runs abnormally slowly when loaded	Connect a flow meter close to the pump. Check the flow. <ol style="list-style-type: none"> 1. The correct flow is obtained when loaded 2. Abnormally low flow obtained when loaded 	<ol style="list-style-type: none"> 1. Pressure relief valve tripped at too low a pressure 2. Worn pump 	<ol style="list-style-type: none"> 1. Adjust the valve or replace if necessary 2. Replace the pump
Noise from the pump	<ol style="list-style-type: none"> 1-5. Check whether the pump cavitates. This is indicated by the noise stopping when the speed drops. Check whether the noise propagates in the hydraulic system 6. Check whether the noise can be heard at all speeds 	<ol style="list-style-type: none"> 1. Too small diameter on the suction hose 2. Crushing or restriction of the suction hose 3. Blocked suction strainer (SLPD). 4. Oil too thick 5. Underpressure in the oil tank 6. Worn pump 	<ol style="list-style-type: none"> 1. Change to a suction hose with a larger diameter 2. Remove the restriction 3. Replace the suction strainer. 4. Change to an oil with a lower viscosity 5. Change the air filter 6. Replace the pump
Oil leakage from the pump	Localise the oil leakage	<ol style="list-style-type: none"> 1. Leakage from the suction connection 2. Leakage from the shaft seal 3. Leakage from the air screws 	<ol style="list-style-type: none"> 1. Replace the O-rings and tighten the hose clips 2. Replace the shaft seals 3. Replace the sealing washers and tighten carefully (15 Nm)
The pump shakes (intermediate shaft assembly)	Check whether the pump shakes, despite the flow not pulsating, i.e. the attachment does not jerk	<ol style="list-style-type: none"> 1. Play on intermediate shaft 2. Incorrect joint angle on intermediate shaft 3. Imbalance on intermediate shaft 4. The universal joints are not in line with each other 	<ol style="list-style-type: none"> 1. Replace the intermediate shaft 2. Ensure that the spindle on the power take off and pump shaft are parallel 3. Rectify the intermediate shaft 4. Loosen and turn the spline coupling so that the universal joints are aligned with each other



If oil leakage has occurred via a damaged shaft seal, ensure that no hydraulic oil has entered the gearbox!



When the pump is running:

1. Do not touch the pressure hose
2. Watch out for rotating parts
3. The pump and hoses may be hot