

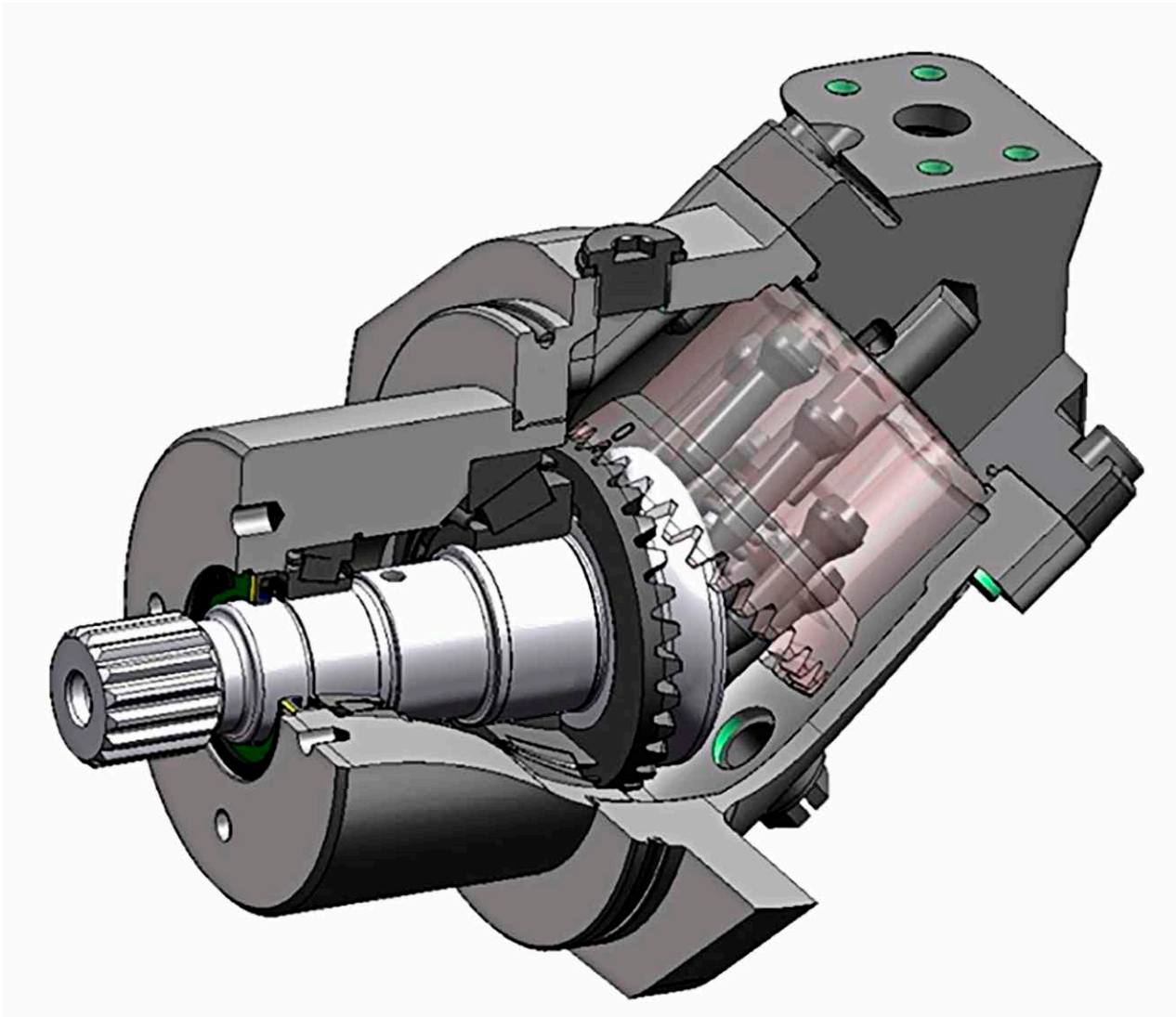

TORQUE / POWER - SCM

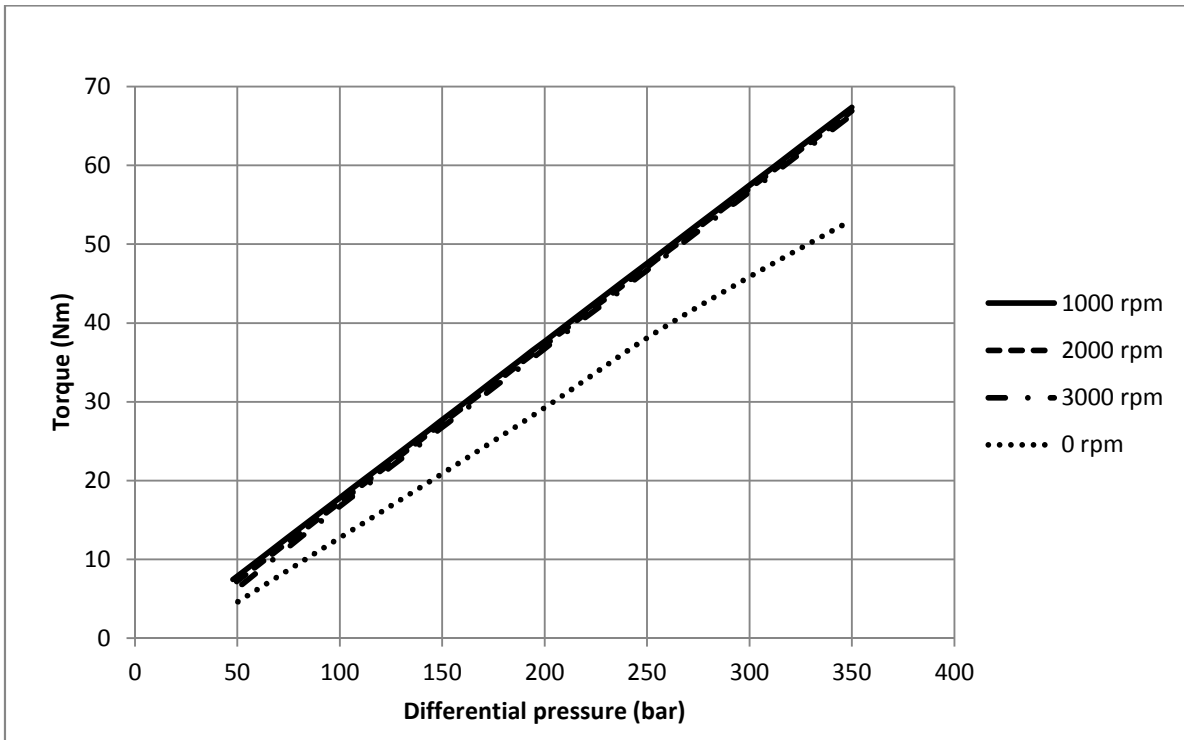

SCM 012 Torque



SCM 012 Power

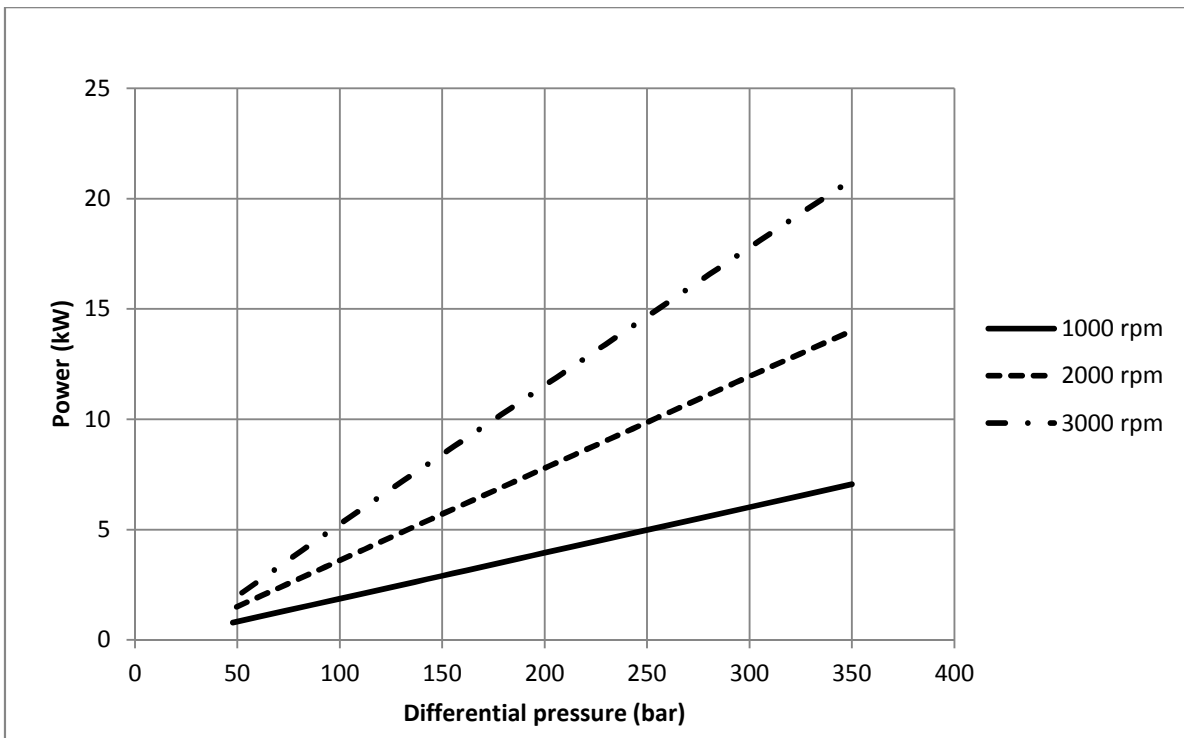

SCM 017 Torque

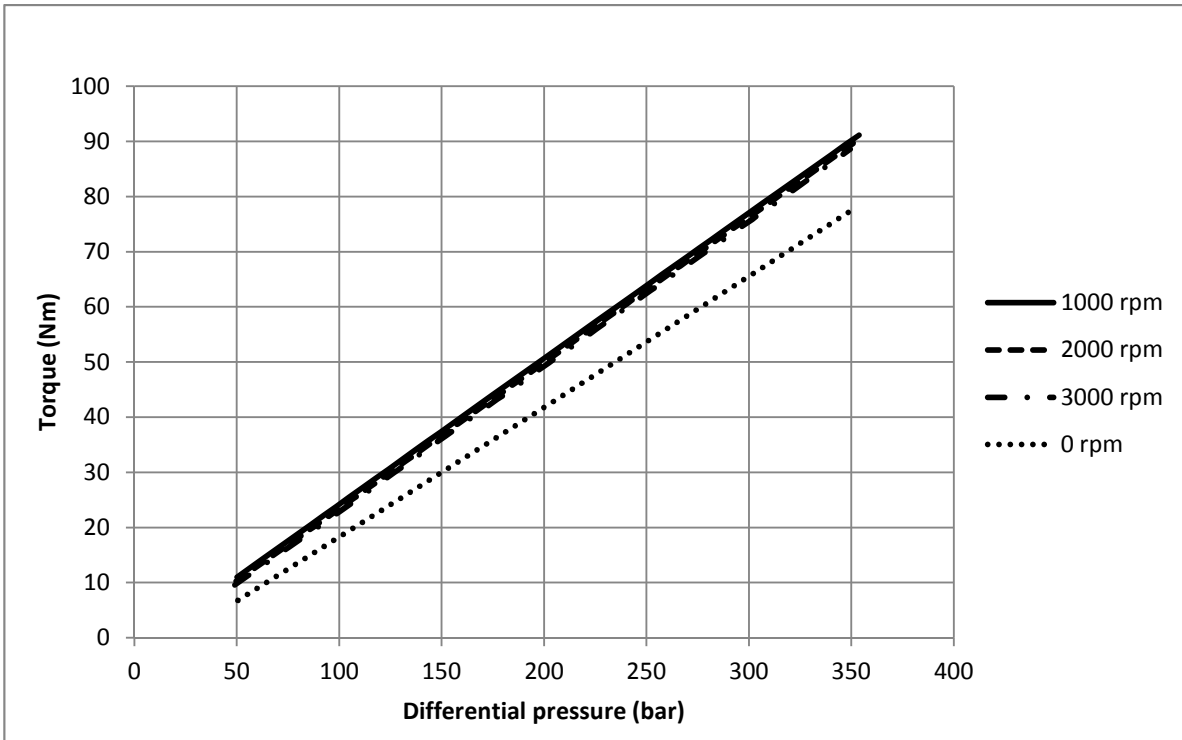

SCM 017 Power

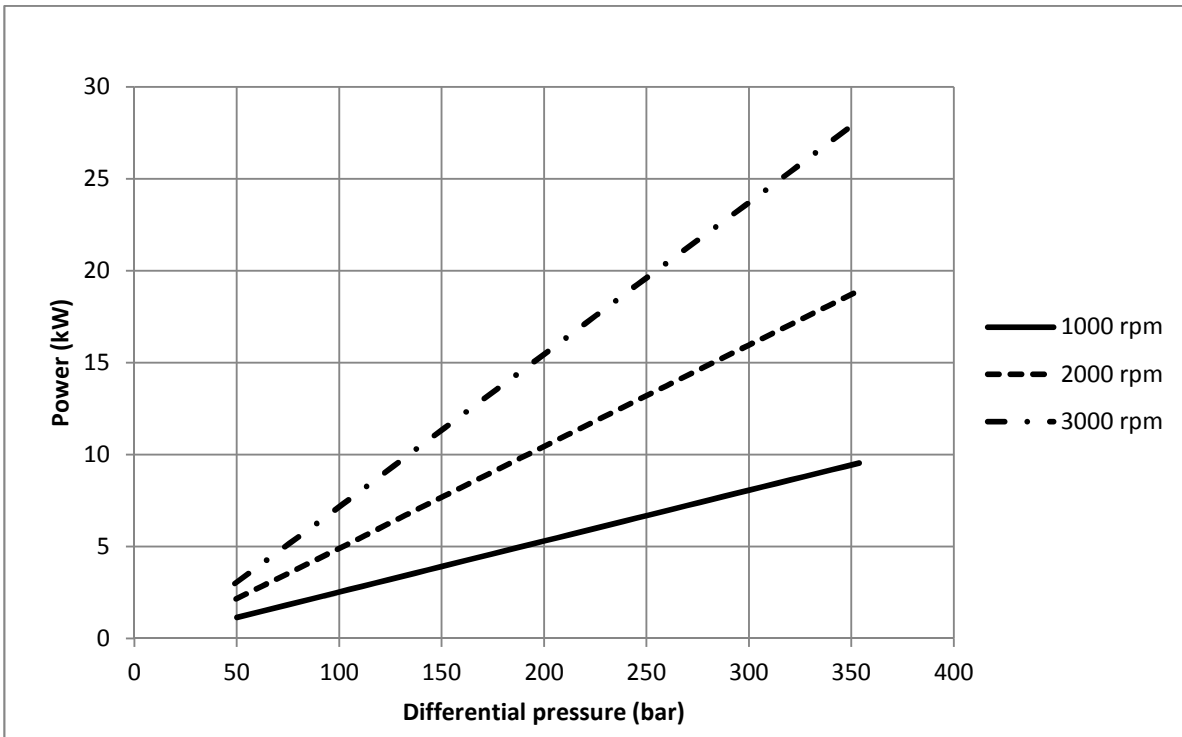

SCM 025 Torque

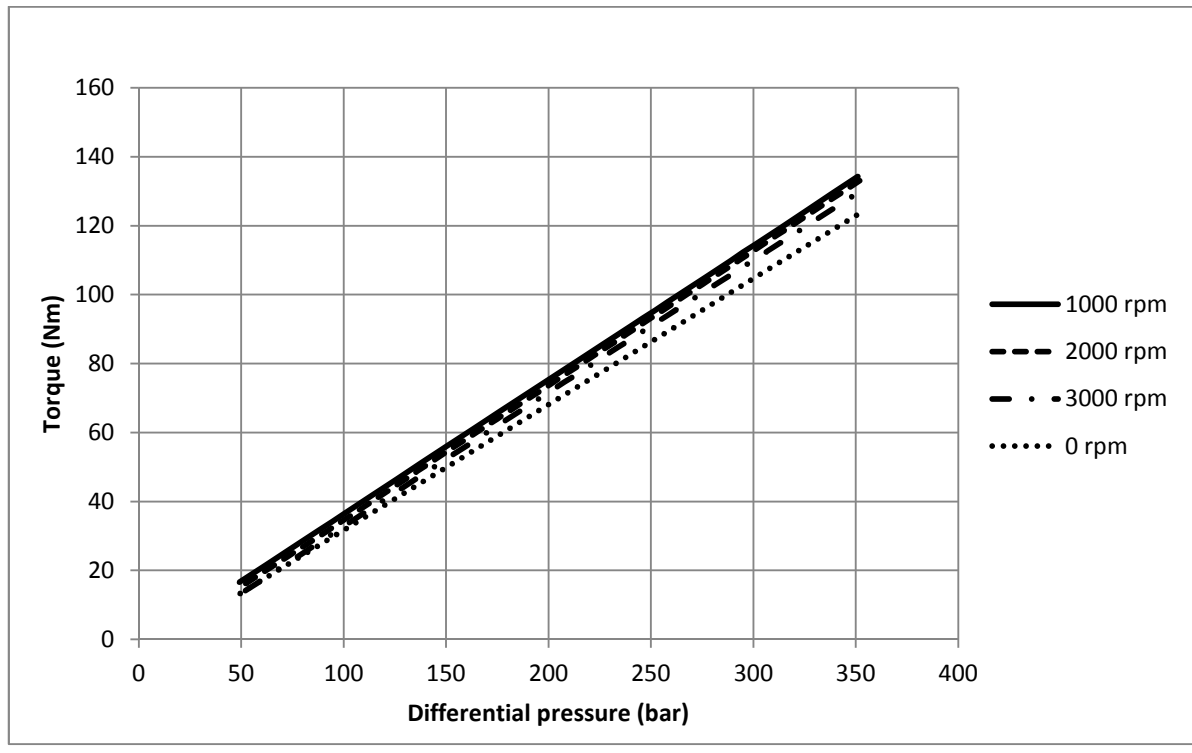

SCM 025 Power

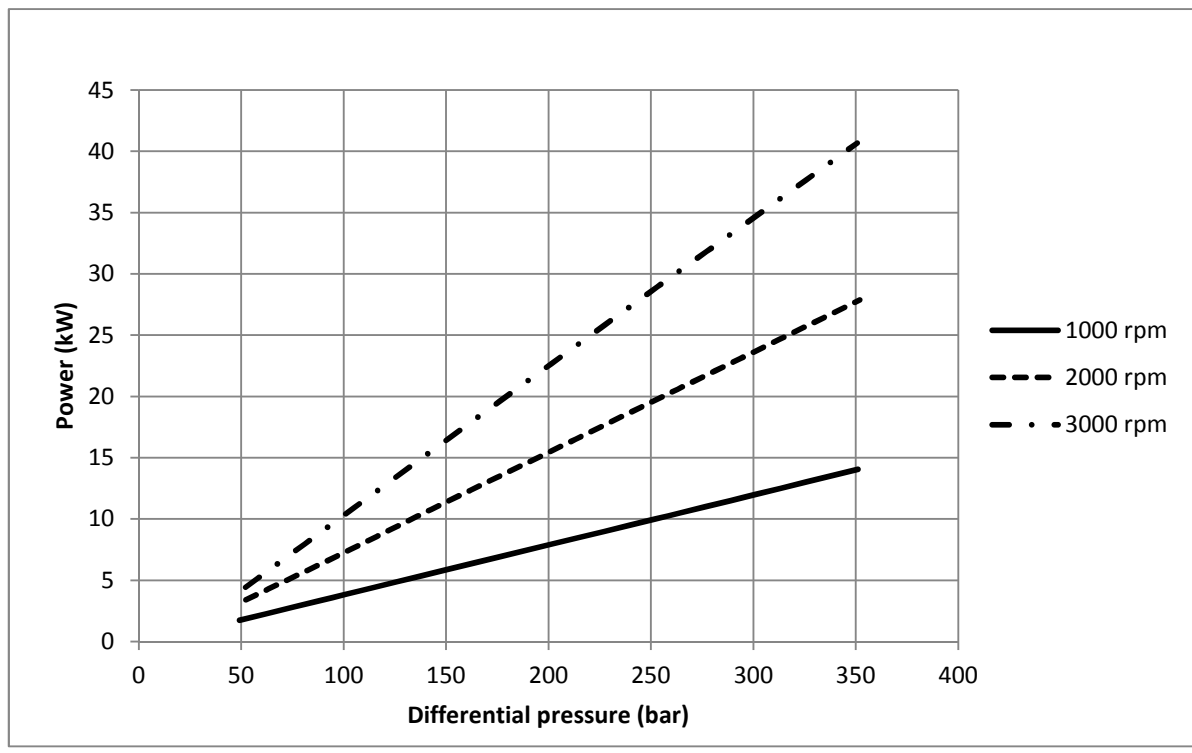

SCM 034 Torque

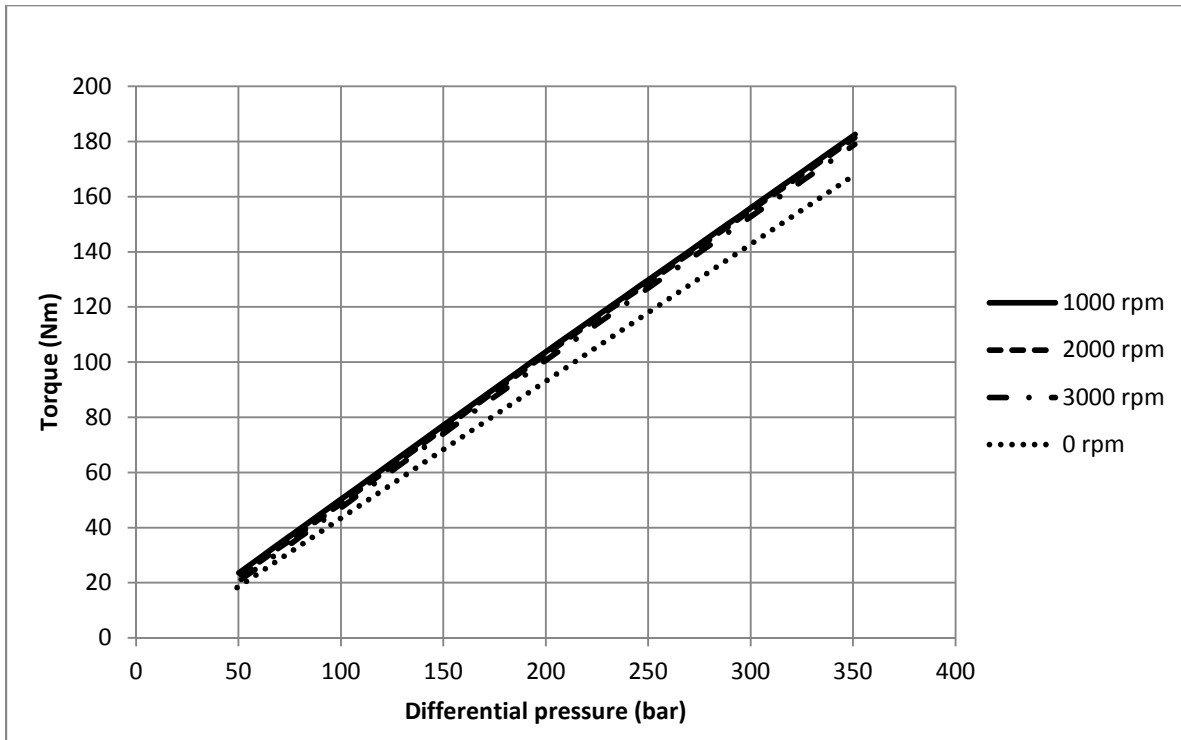

SCM 034 Power

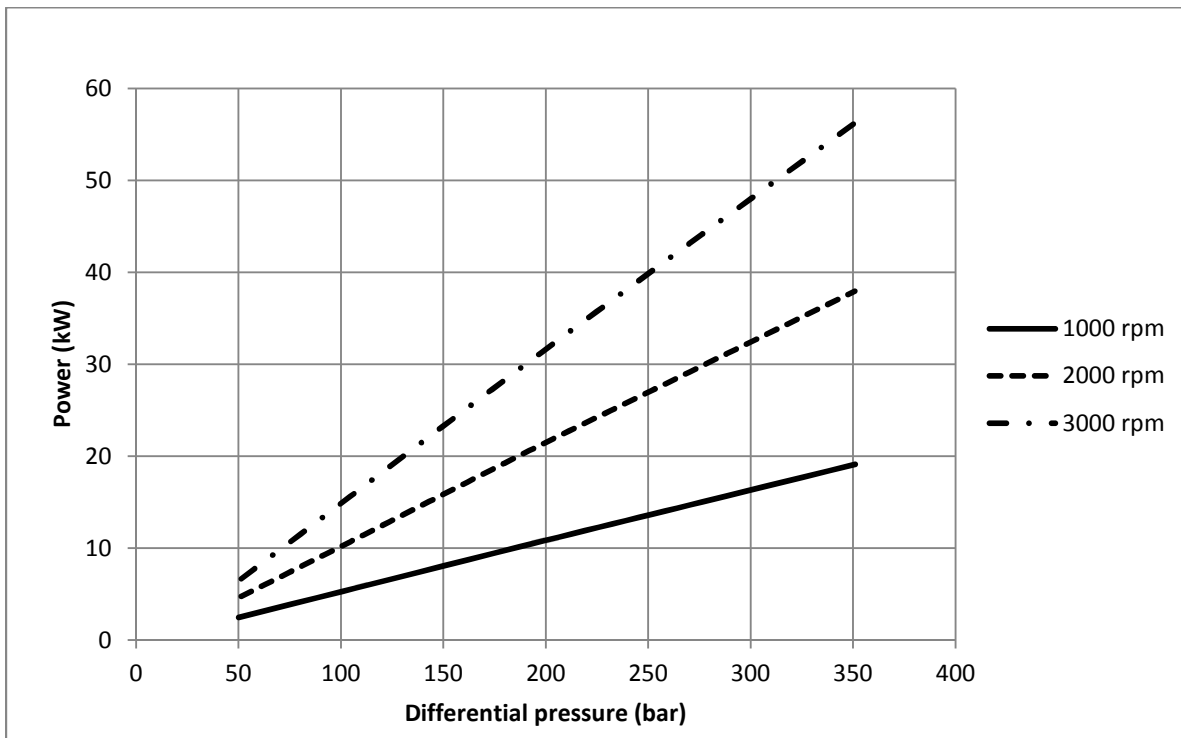

SCM 040 Torque

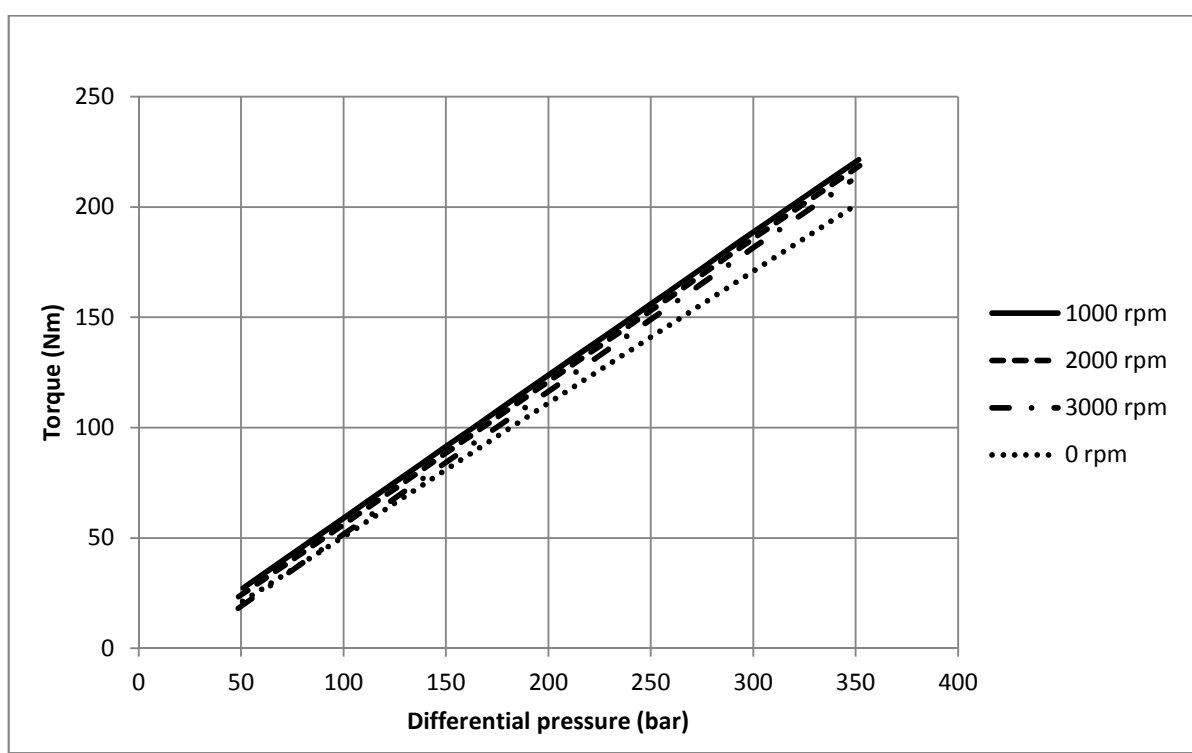

SCM 040 Power

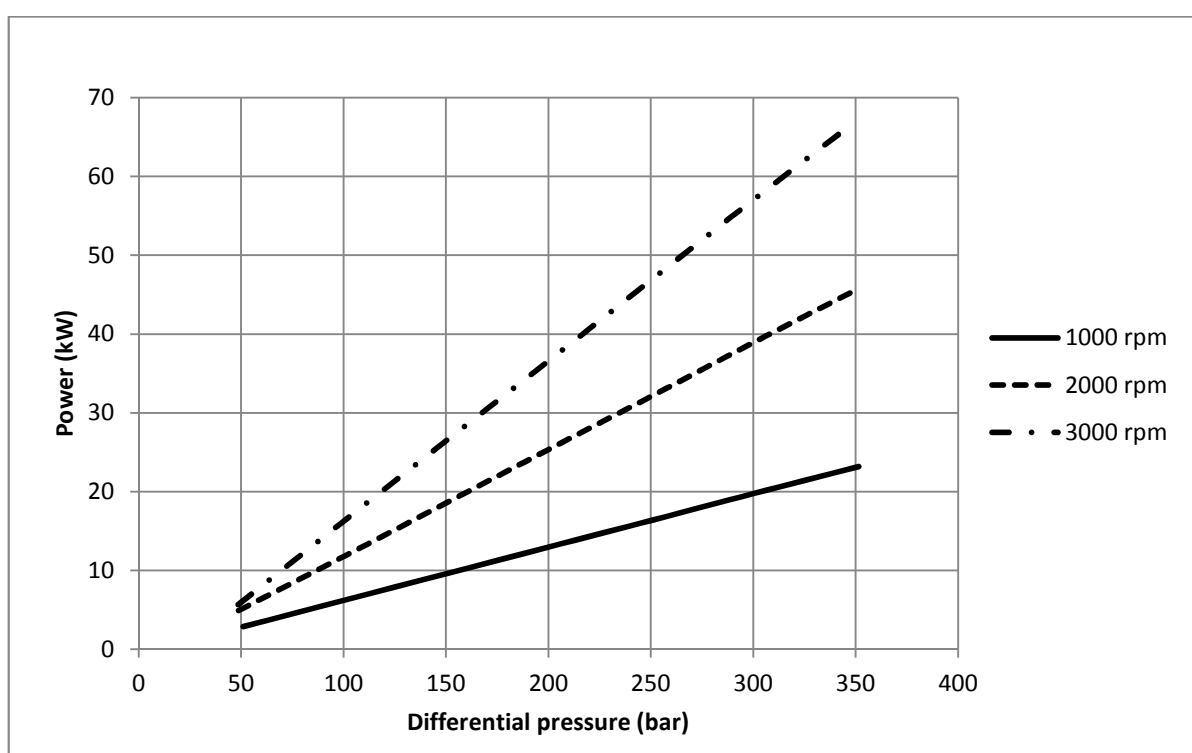

SCM 047 Torque

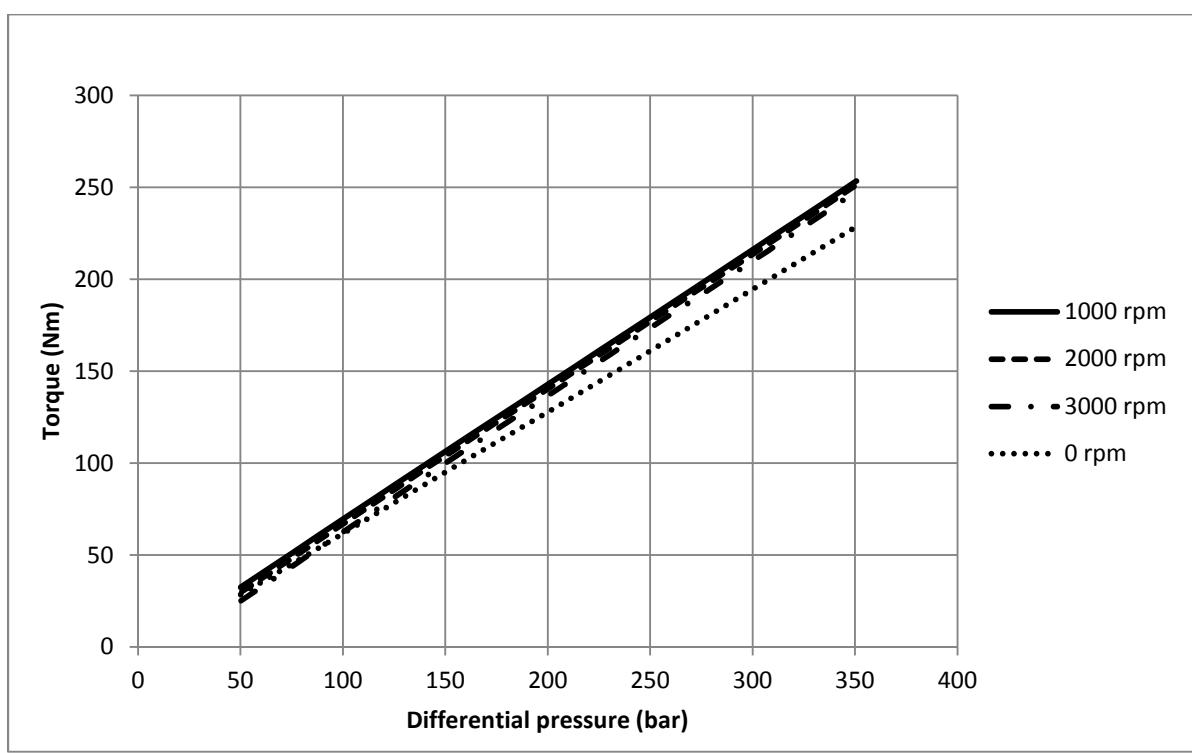

SCM 047 Power

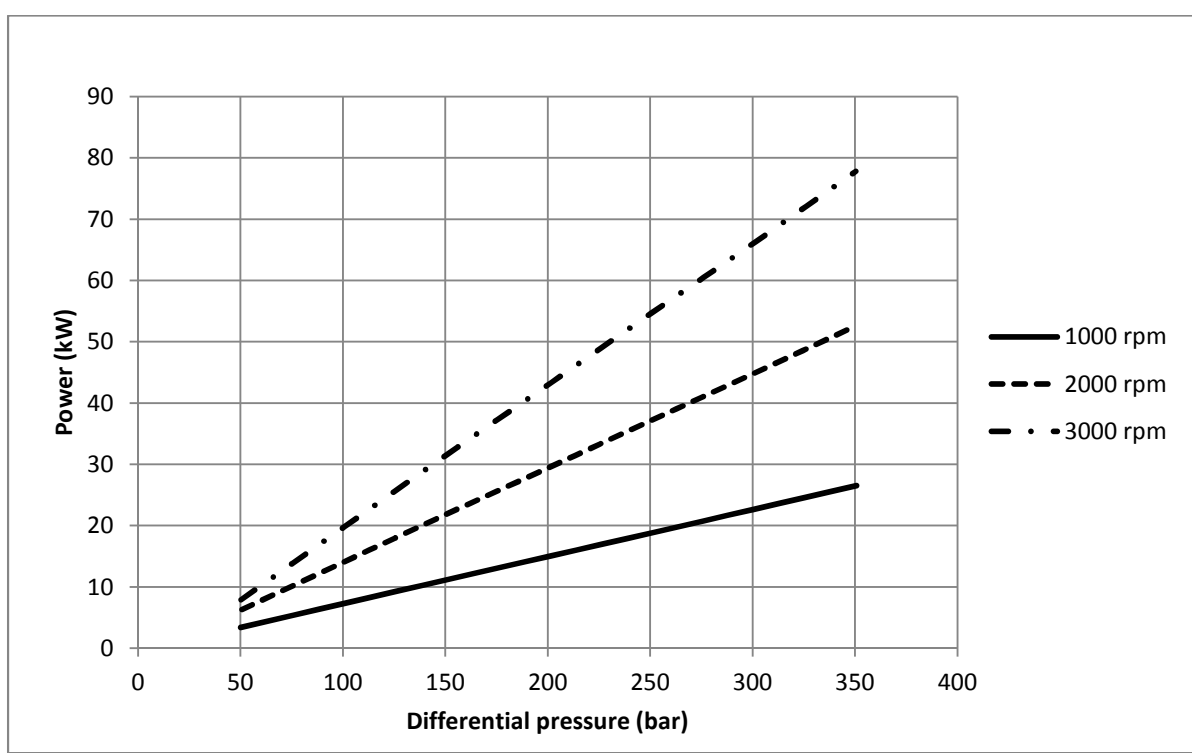

SCM 056 Torque

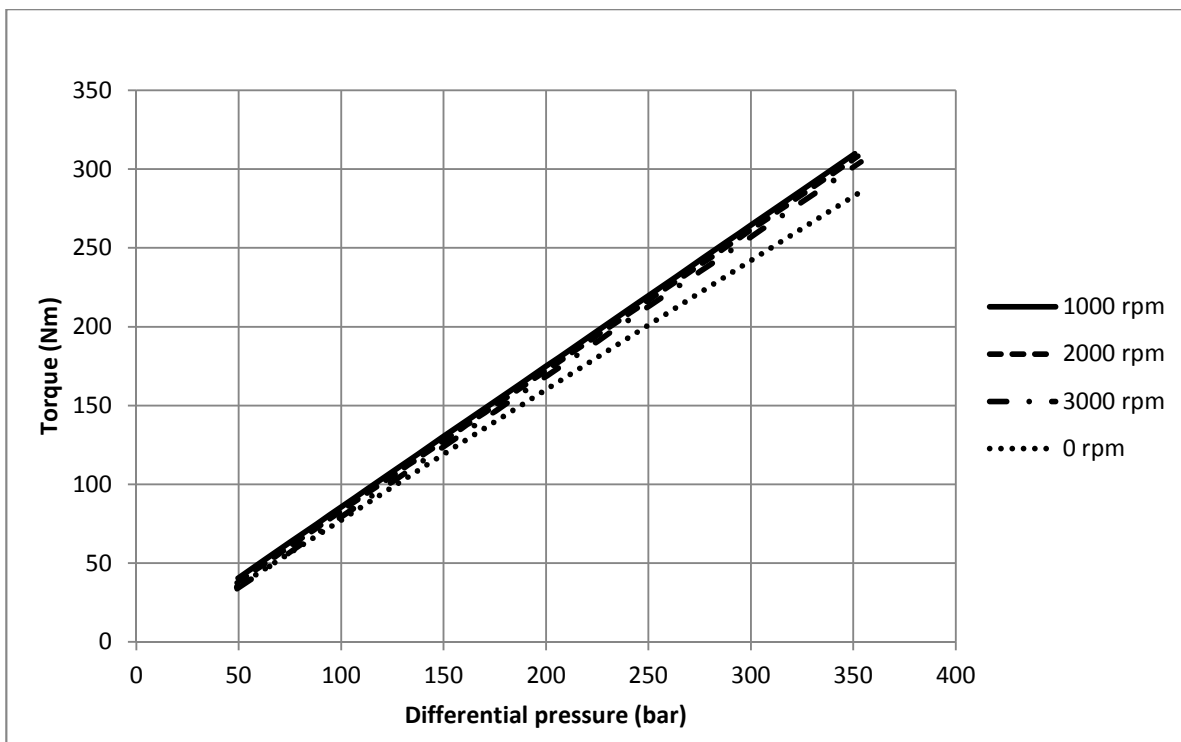

SCM 056 Power

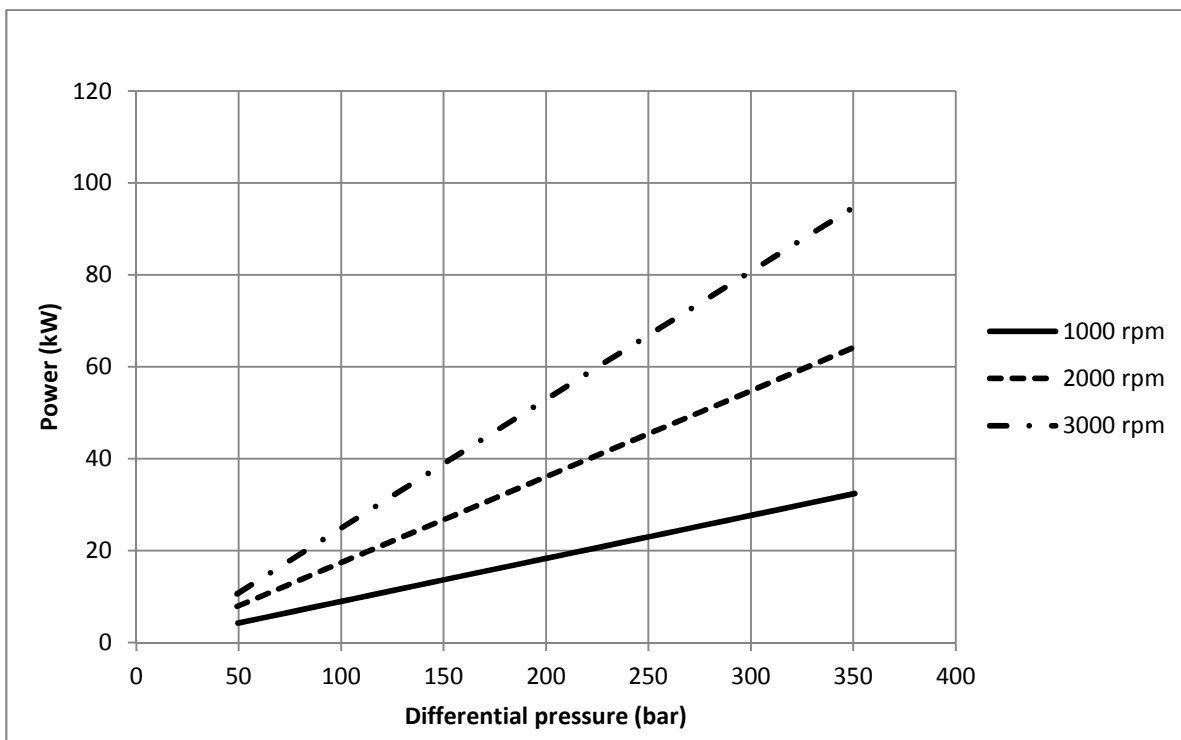

SCM 064 Torque

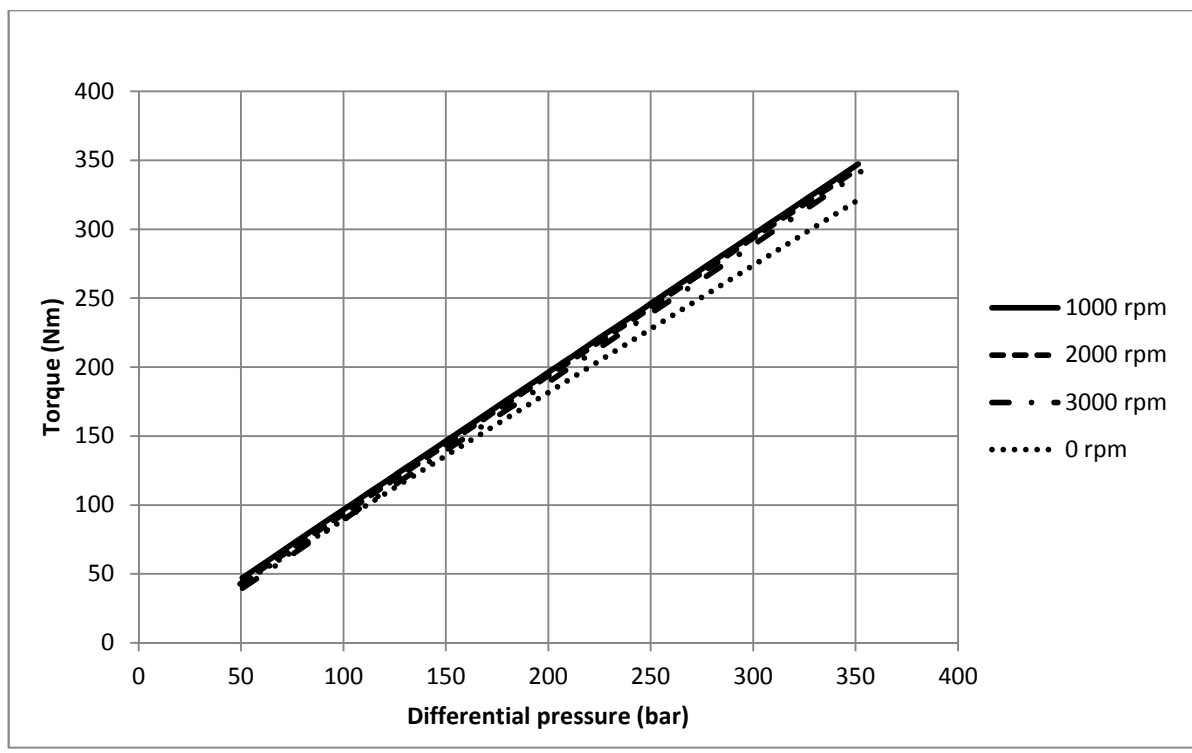

SCM 064 Power

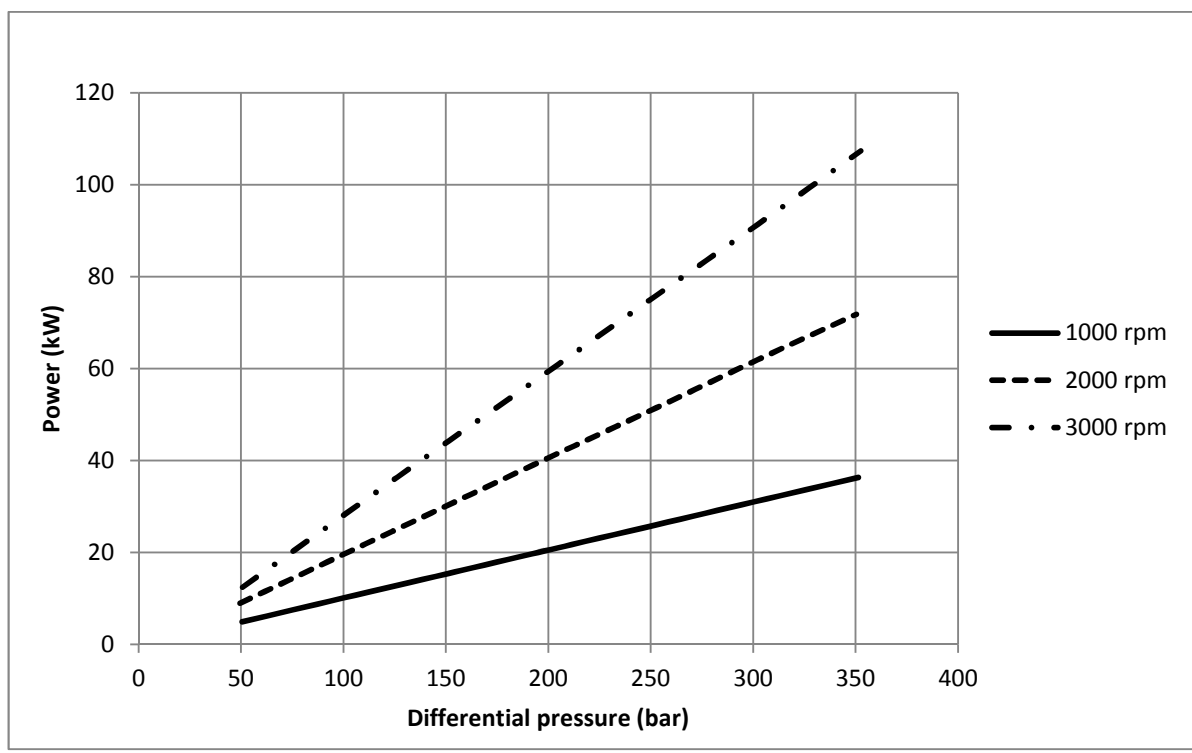

SCM 084 Torque

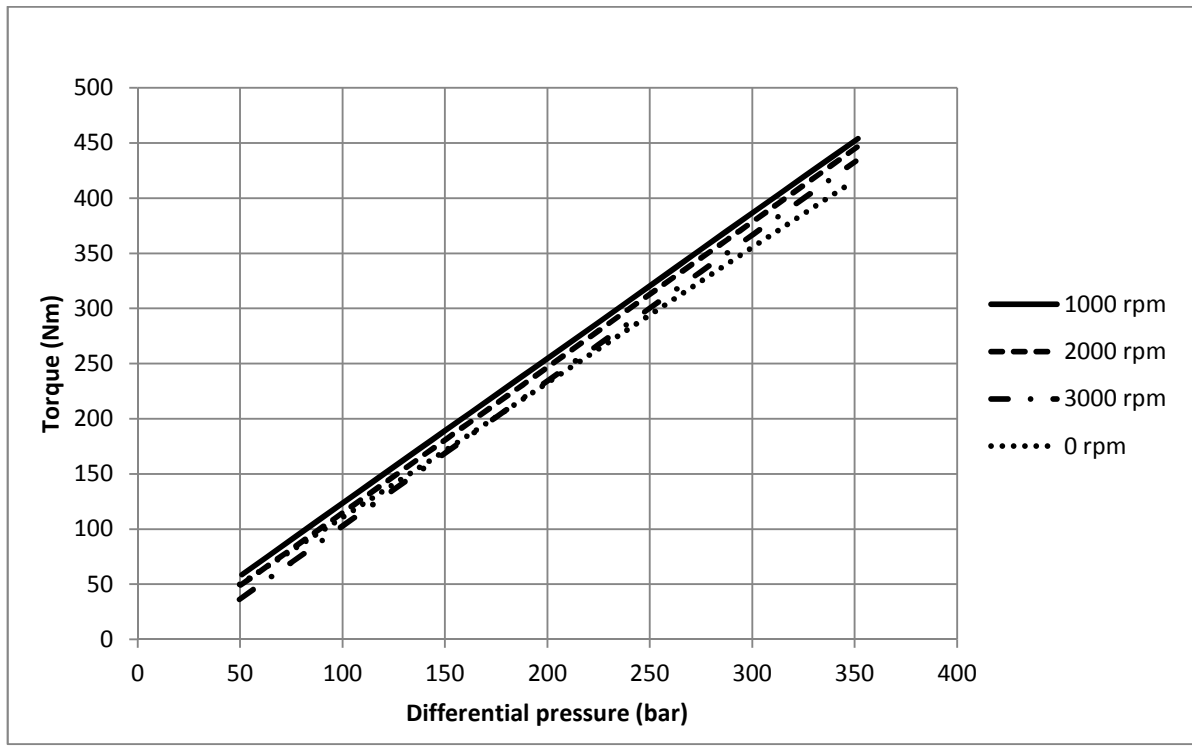

SCM 084 Power

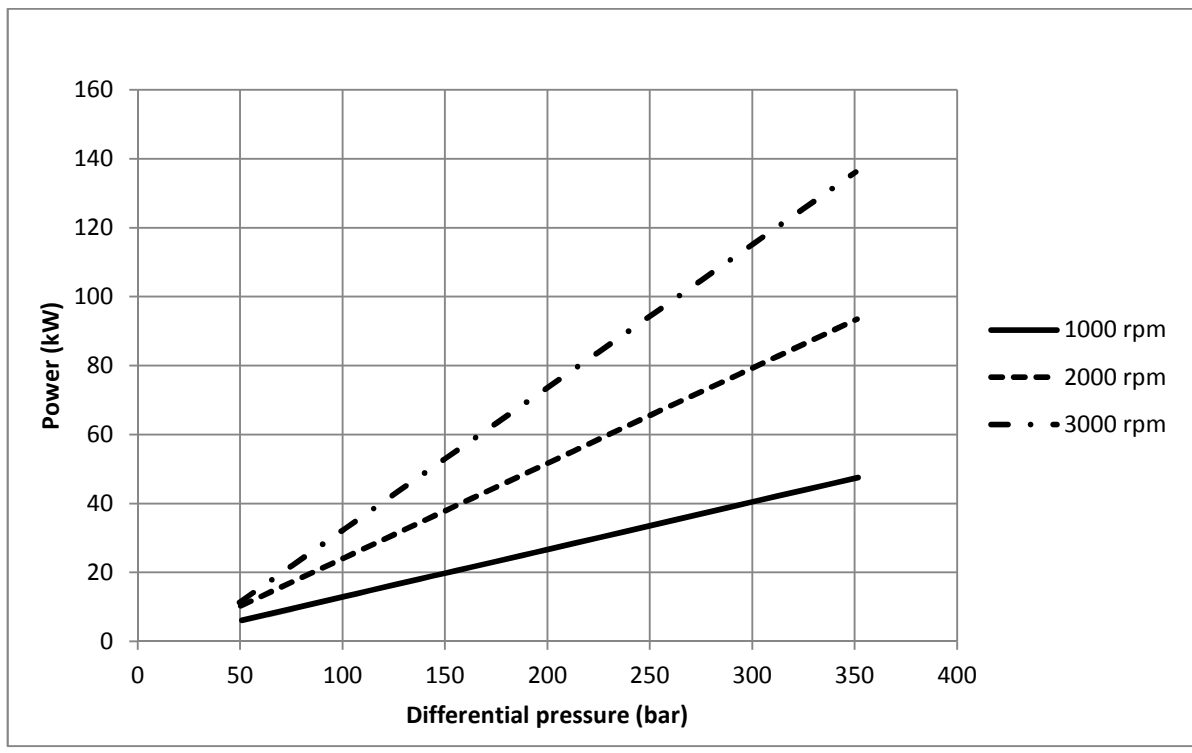

SCM 090 Torque

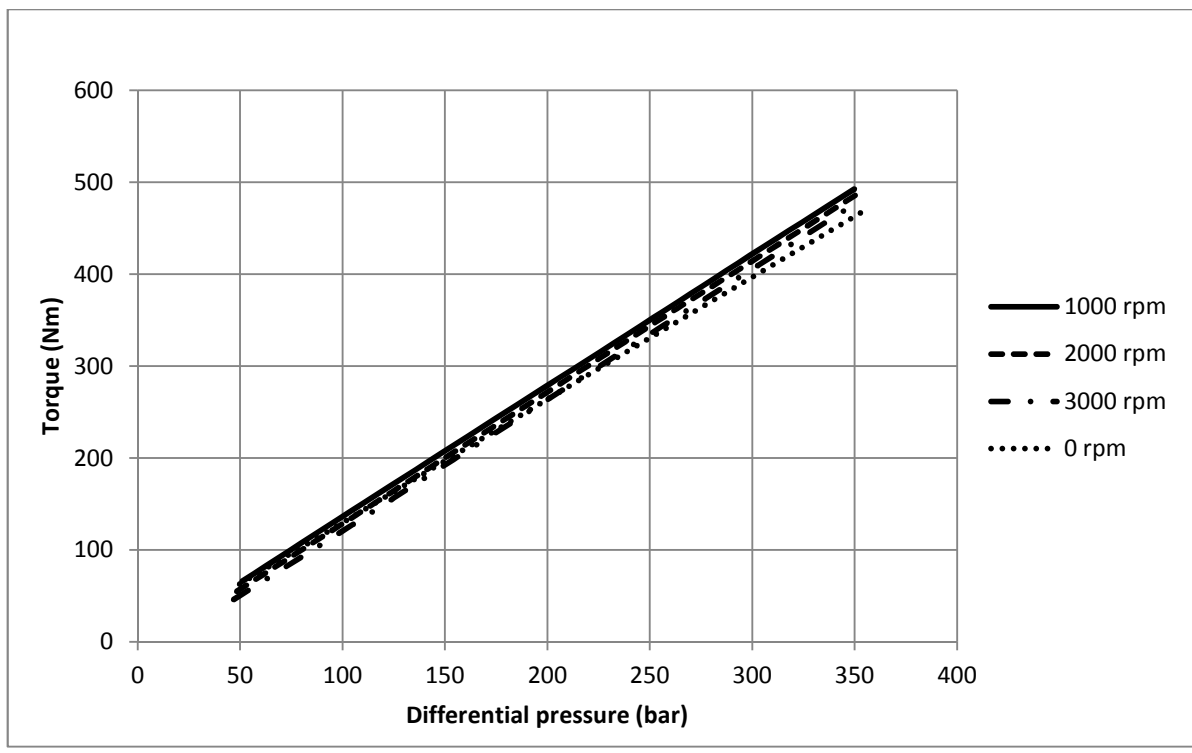

SCM 090 Power

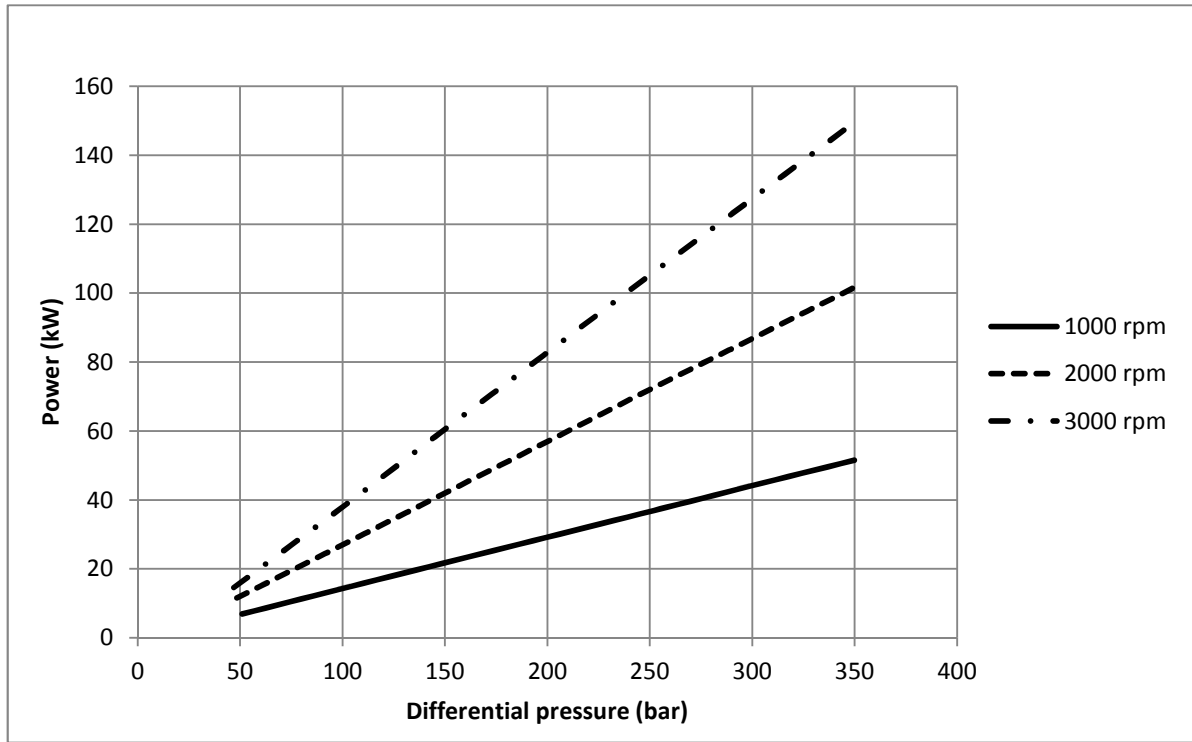



SCM 108 Torque

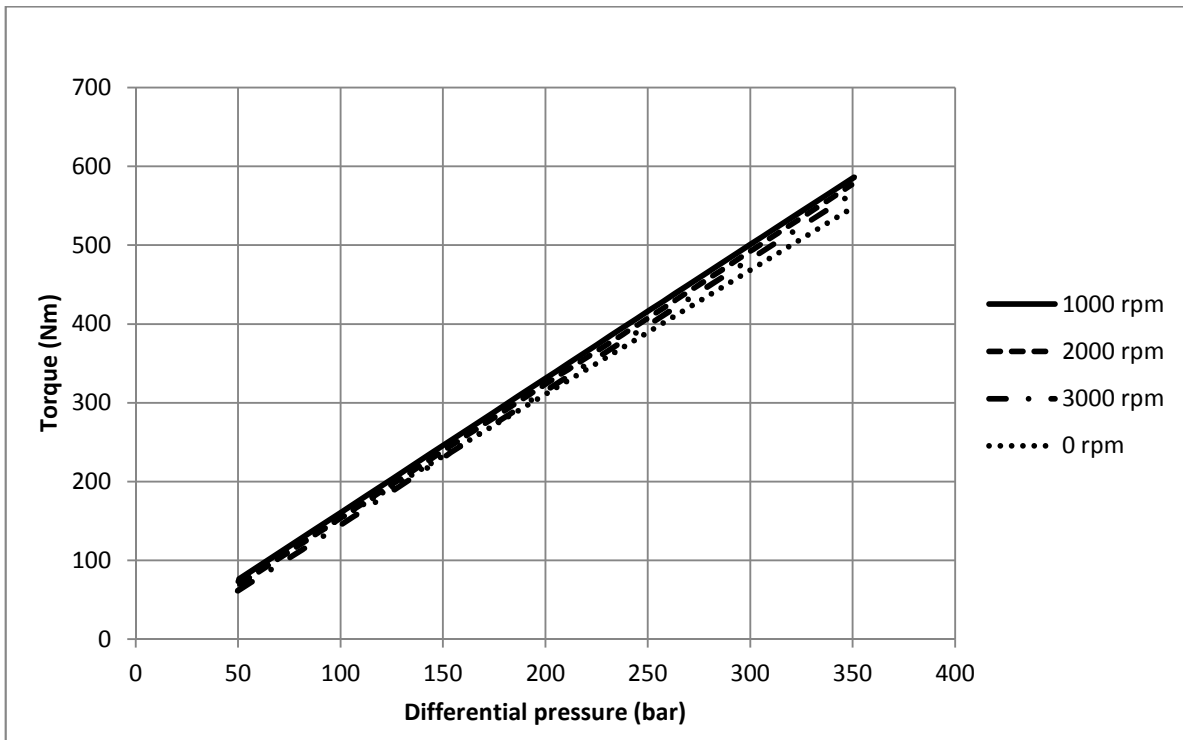

SCM 108 Power

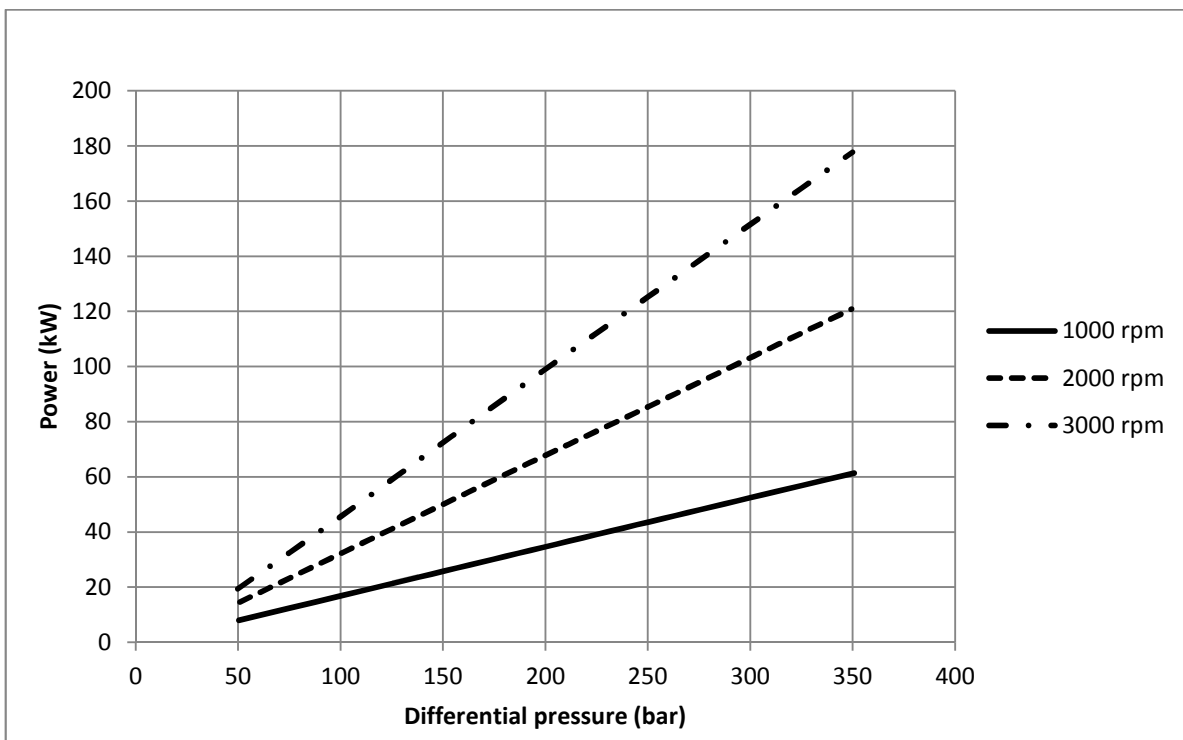

SCM 130 Torque

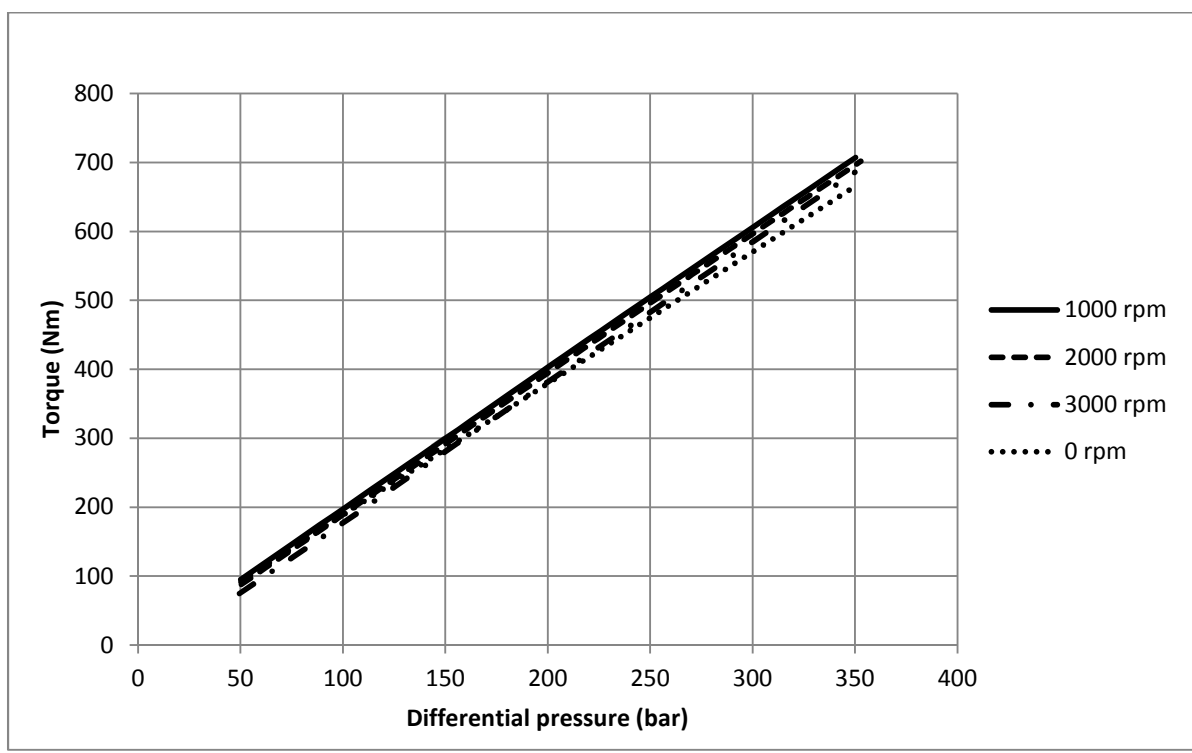

SCM 130 Power

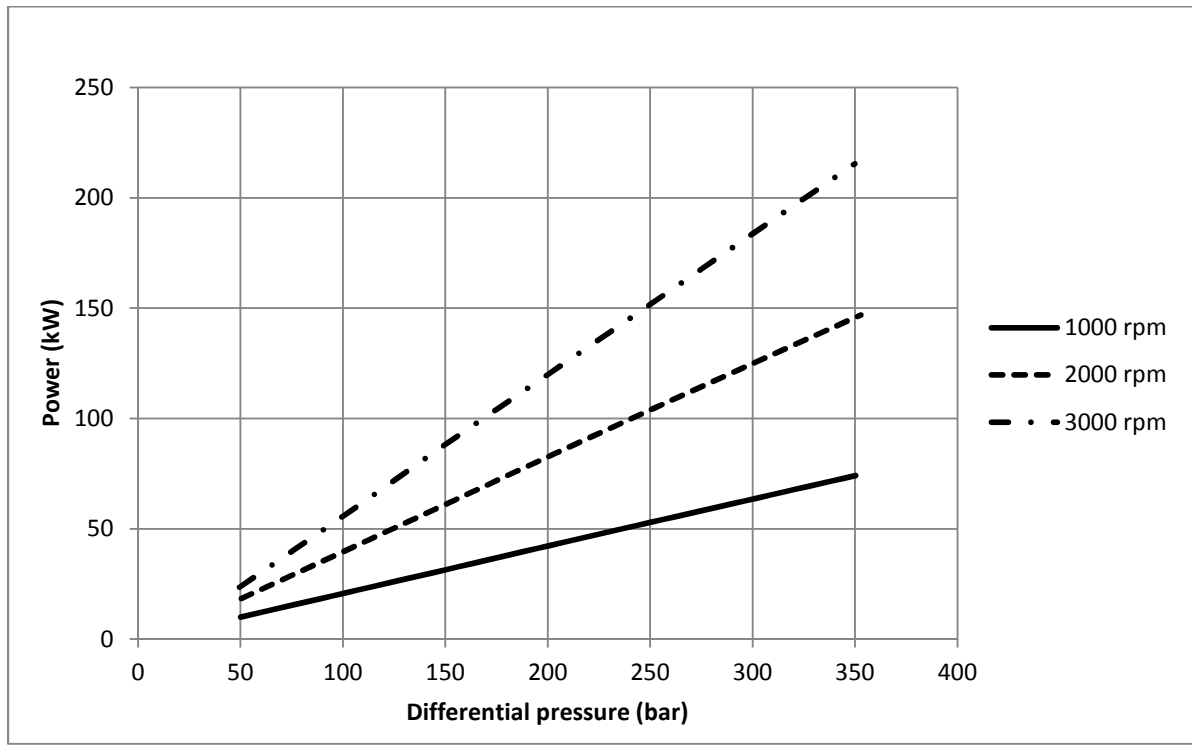

Sunfab reserves the right to make changes in design and dimensions without notice. Printing and typesetting errors reserved.
 © Copyright 2015 Sunfab Hydraulics AB. All Rights Reserved.